

MT-5054 RJ45 Modular Plug 8P8C Plug STP CAT.7 Type



Quick Details:

1. Place of Origin: Zhejiang, China
2. Brand Name: Melontel
3. Model Number: MT-5054
4. Type: RJ45, 8P8C Plug STP Cat.7
5. Application: Power, Telephone and Network
6. Gender: Male
7. Pins: 8P
8. Weight: 2.99g
9. Gold Plated: $F\mu$, 3μ , 50μ

10. Operating Life: 500 Cycles min

11. Color: Transparent

Feature:

1. Dovetail clip design, effectively fix the network cable to ensure stable signal transmission
2. Shrapnel strengthening, resistance to bend
3. The outer layer is protected by an metal shell, can effectively resist external electromagnetic interference and better screening
4. PC material and durable
5. Trident gold plated chip, data transmission is more stable

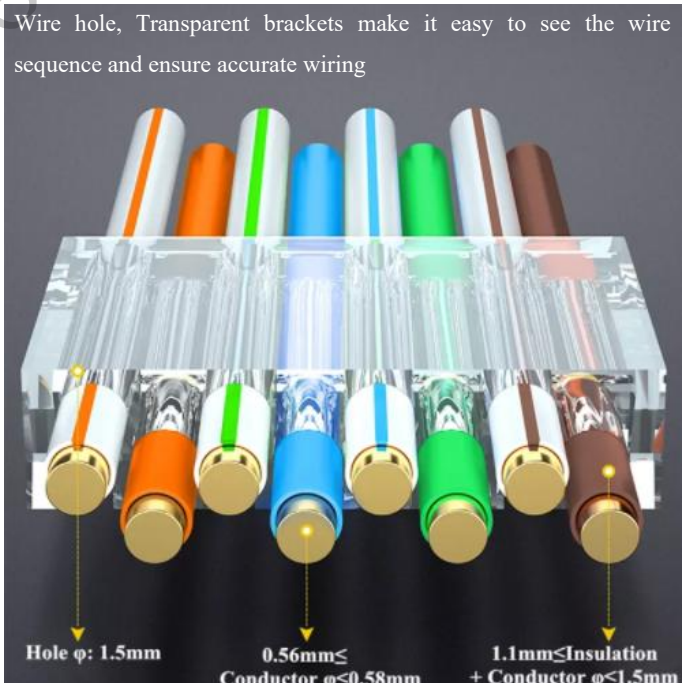

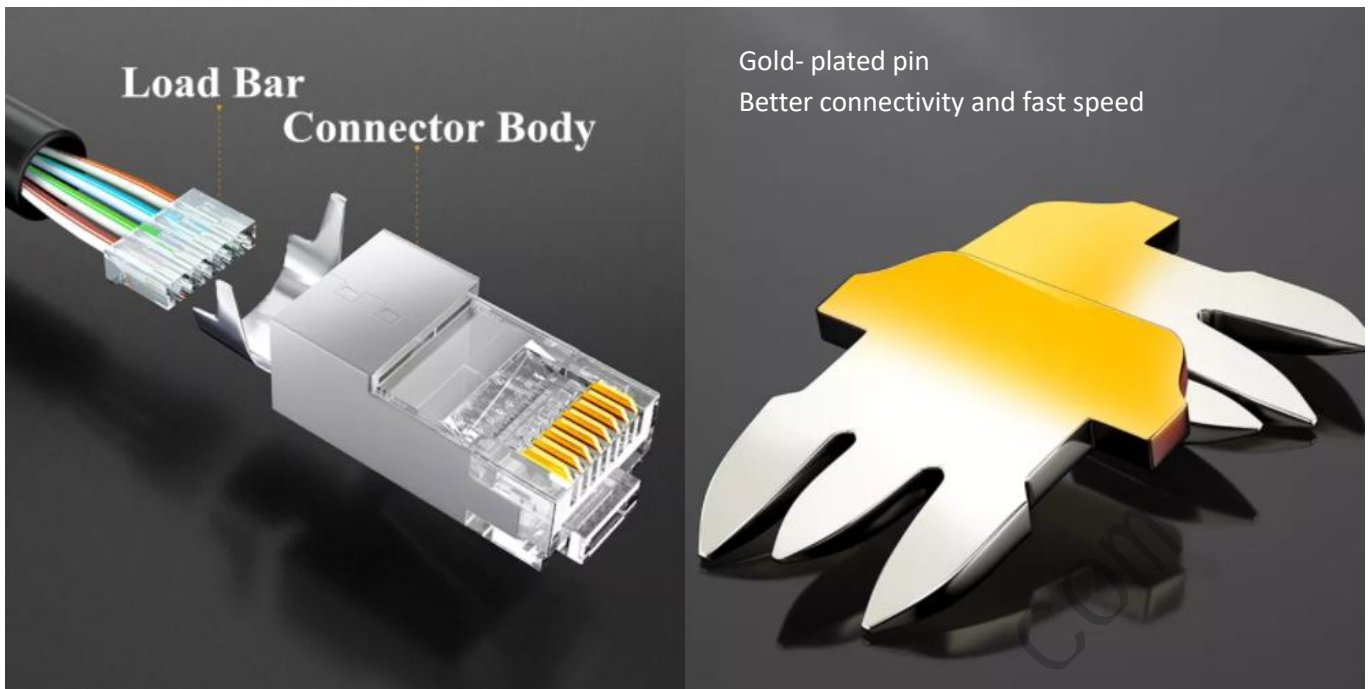

Drawing:

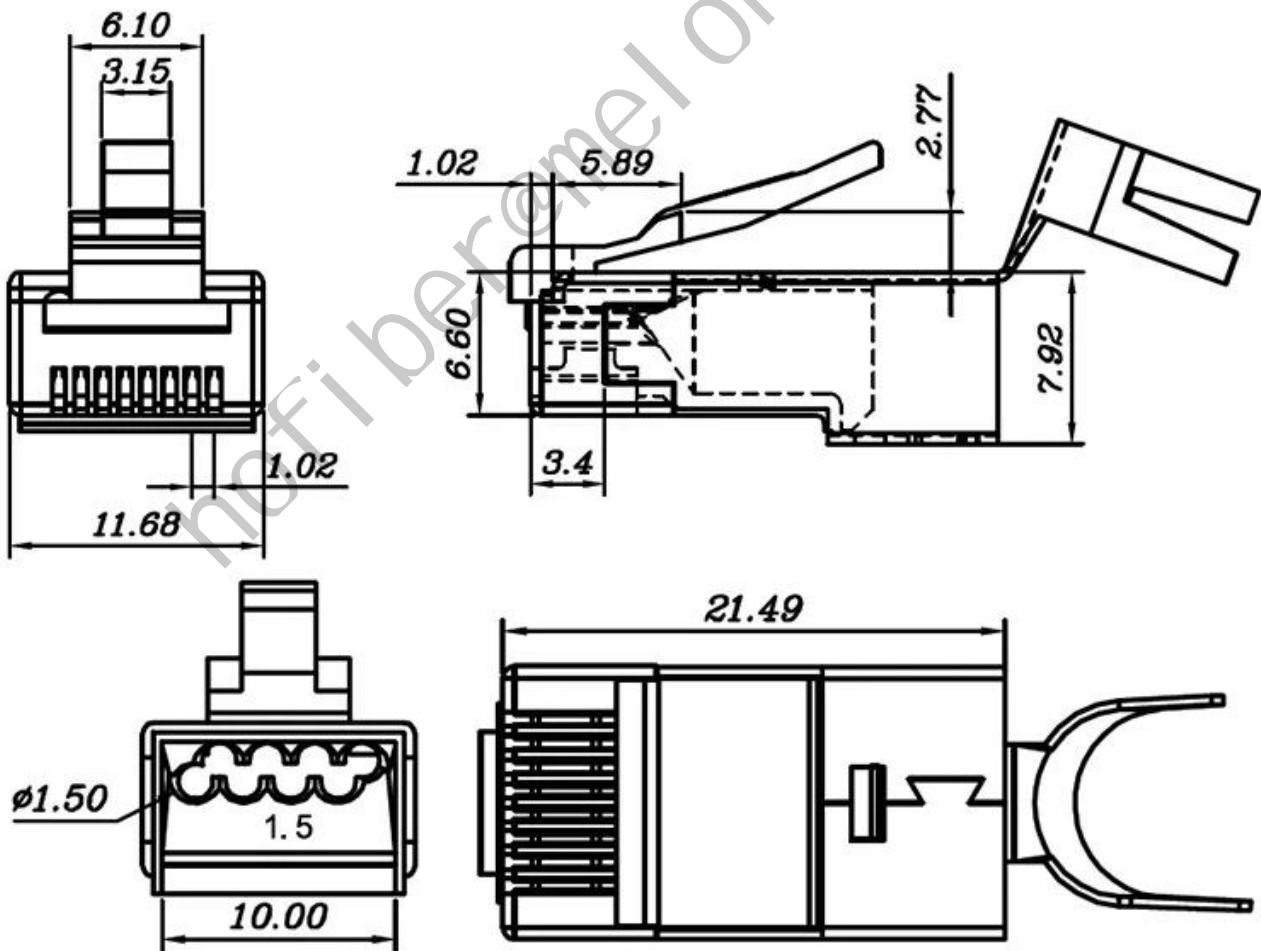

Standard Network Cabling Method:



568A Standard

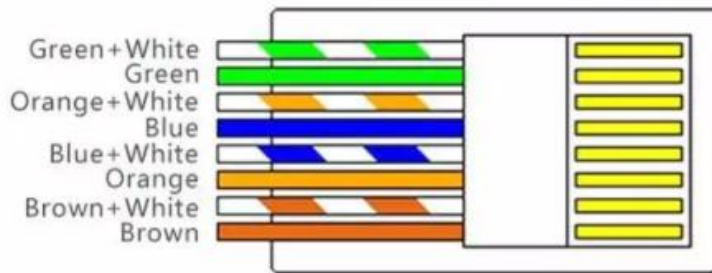

568B Standard

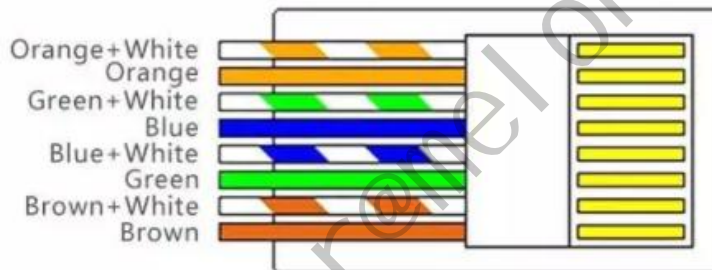

Made for:

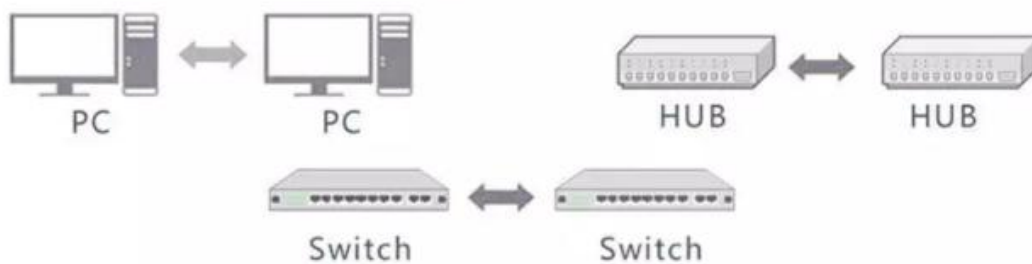

Straight-Through Cable

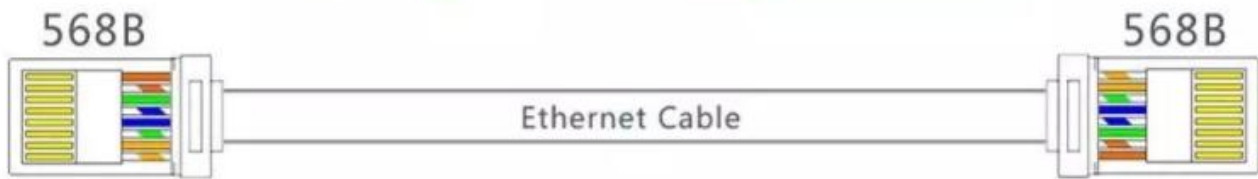

Made for:

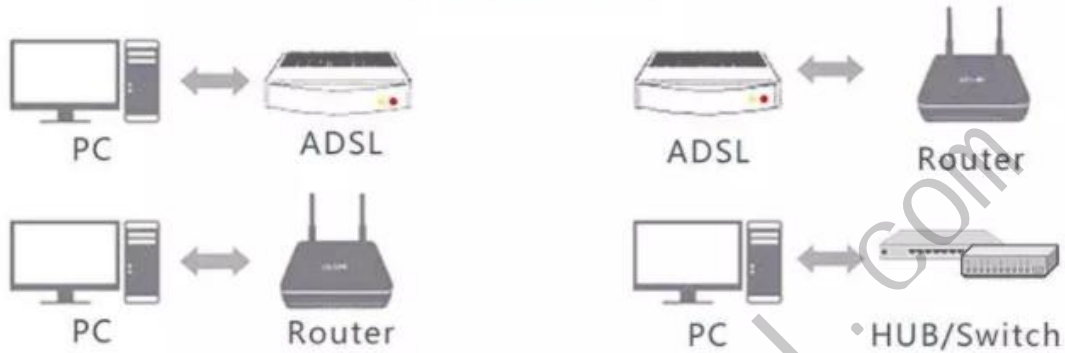

Application:



Usage:

How to create a patch cord





More pictures:

